

REHAUSSES & ACCESSOIRES D'ANCRAGE BIONUT 2

Accessoires

6062

REHAUSSES FOSSES TOUTES EAUX

RH2/4031-15
FTE : 3 M³

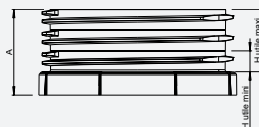

RH2/03/15
FTE : 4,5,6,8 & 10 M³

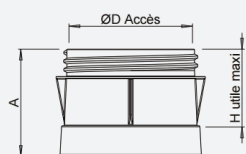

RH2/6030
FTE : 6, 8 & 10 M³

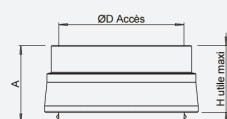

REHAUSSES POSTE DE RELEVAGE

RH2/4031
RELBIONUT-B2

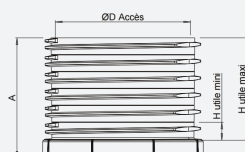

REHAUSSES DE REGARD DE RÉPARTITION ET CHASSE À AUGET

RH2/03/15

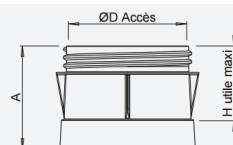

REHAUSSES BIONUT

RH2/15/B2

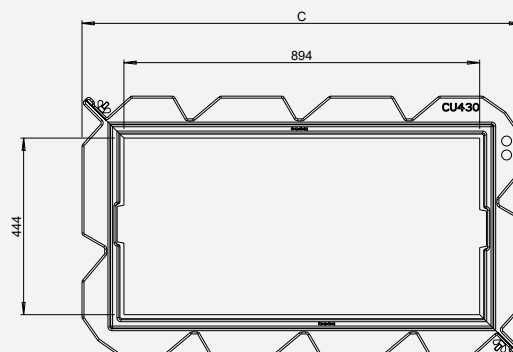
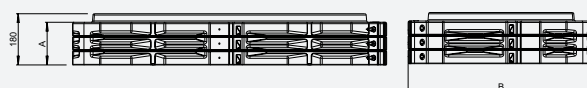
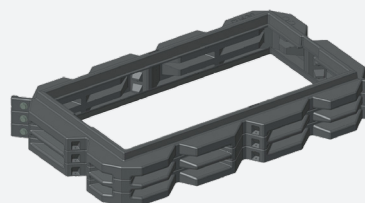

RH2/3030/B-3

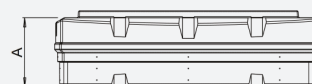

Référence	Désignation	A	ØD Accès	H utile mini	H utile maxi
RH2/4031-15	Rehausse trou d'homme à visser recoupable tous les 5 cm	207	Ø400	50	150
RH2/03/15	Rehausse diffuseur de fosse toutes eaux ou de l'auget flottant	200	Ø220	150	150
RH2/6030	Rehausse fosse toutes eaux 6,8 et 10 m ³	357	Ø600	300	300
RH2/4031	Rehausse trou d'homme et poste de relevage à visser, recoupable tous les 5 cm	357	Ø400	50	300

Référence	Désignation	A	B	C
RH2/15/B2	Rehausse BIONUT de 150 mm - à assembler	150	740	1170
RH2/3030/B-3	Lot de 3 réhausse BIONUT non réglables de 300 mm	300	740	1170

TRAITEMENT DES EAUX USÉES | ANC < 20 EH

Rehaussees fournies de série avec les filièrès BIONUT2 de 4 et 8 EH

			Composition des packs rehaussees			
						
			RH2/03/15	RH2/4031-15	RH2/15/B2	RH2/4031
Hauteur	En mm	Références de la filièrè	150	150	150	300
SORTIE BASSE	4 EH	BIONUT2/6054/04 ou 04SN		2	1	
	5 EH	BIONUT2/6054/05 ou 05SN		2	1	
	6 EH	BIONUT2/6054/06 ou 06SN		2	1	
	8 EH	BIONUT2/6054/08 ou 08SN	1	1	2	
SORTIE HAUTE	4 EH	BIONUT2/6054/04SH ou 04SNSH		2	1	1
	5 EH	BIONUT2/6054/05SH ou 05SNSH		2	1	1
	6 EH	BIONUT2/6054/06SH ou 06SNSH		2	1	1
	8 EH	BIONUT2/6054/08SH ou 08SNSH	1	1	2	1

Accessoires d'ancrage de Bionut2

AVEC SANGLES (soit fixées aux barres d'ancrage, soit passées simplement dans les inserts des cuves en partie basse)		AVEC SANGLES (soit fixées aux barres d'ancrage, soit passées simplement dans les inserts des cuves en partie basse)		
Capacité	KANCRB2 = 1 barre d'ancrage AD254 + 2 goupilles BV170-8-100	SANS WINCH		AVEC WINCH
		Lot de 2 ceintures d'ancrage CA3/10/3T/2	Lot de 3 ceintures d'ancrage * CA3/10/3T/3	Ceinture d'ancrage à l'unité CA3/6394/10T
4 EH	2	1		2
5 EH	2	1		2
6 EH	2	1		2
8 EH		2		4
10 EH	4	3		6
12 EH	4	3		6
16 EH		2	1	6
18 EH	6	3	1	8
20 EH	8	4	1	10

* Pour les FTE de 8 et 10 m³

Tableau de synthèse des rehausSES et packs de rehausSES proposés en option.

Composition de chaque pack de rehausSES							
Hauteur	En mm	Références des packs	150	300	300	150	
SORTIE BASSE	4 à 6 EH	RHV/BIONUT2/456/SB		2		2	
	4 à 6 EH	RHV/BIONUT2/SB		2			1
	8 EH	RHV/BIONUT2/08/SB	2	1		4	
	10 EH	RHV/BIONUT2/10/SB	4	1		4	
	12 EH	RHV/BIONUT2/12/SB	2		1	4	
	16 EH	RHV/BIONUT2/16/SB	2		1	8	
	18 EH	RHV/BIONUT2/18/SB	4		2	6	
	20 EH	RHV/BIONUT2/20/SB	4		2	8	

SORTIE HAUTE	4 à 6 EH	RHV/BIONUT2/456/SH		3		2	
	4 à 6 EH	RHV/BIONUT2/SH		3			1
	8 EH	RHV/BIONUT2/08/SH	2	2		4	
	10 EH	RHV/BIONUT2/10/SH	4	2		4	
	12 EH	RHV/BIONUT2/12/SH	2	1	1	4	
	16 EH	RHV/BIONUT2/16/SH	2	1	1	8	
	18 EH	RHV/BIONUT2/18/SH	4	1	2	6	
	20 EH	RHV/BIONUT2/20/SH	4	1	2	8	

Type et nombre de rehausSES par équipement

Fosse toutes eaux seule	4, 5, 6 EH	FTE03000BI Entrée diffuseur		1			
		FTE03000BI Sortie préfiltre		1			
	8 EH	FTE2/6009/04 Entrée diffuseur	2				
		FTE2/6009/04 Sortie préfiltre		1			
	10 EH	FTE2/6009/05 Entrée diffuseur	2				
		FTE2/6009/05 Sortie préfiltre		1			
	12 EH	INR06000 Sortie préfiltre			1		
	16 EH	INR08000 Sortie préfiltre			1		
18, 20 EH	FTE2/6309/10 Entrée diffuseur			1			
	FTE2/6309/10 Sortie préfiltre			1			
Auget	AF2/6016/055 (18 & 20 EH)	2					
Regard	REP2/04/04 (> 8 EH)	2					
Filtre compact seul	4, 5, 6 EH	BIONUT2/6054/04 - 05 - 06				2	
	8 EH	BIONUT2/6054/08				4	
	10 EH	BIONUT2/6054/10				4	
	12 EH	BIONUT2/6054/12				4	
	16 EH	BIONUT2/6054/16				8	
	18 EH	BIONUT2/6054/18				6	
	20 EH	BIONUT2/6054/20				8	
Relevage	RELBIONUT-B2		1				